

# Multipla



ASSA ABLOY, the global leader  
in door opening solutions



# Multipla

## Elettroserrature per porte e cancelli

### Caratteristiche tecniche:

- Reversibile
- Entrata unica regolabile da 50 a 70 mm.
- Incontro regolabile in altezza
- Interassi dei fori di fissaggio unificati
- Scocco autobloccante
- Con cilindro fisso o staccato
- Scatola in acciaio
- Alimentazione 8 - 12 V
- Finiture
  - Zincata
  - Verniciata grigio metallizzato

### Confezione:

- 3 Chiavi
- 1 Bocchetta
- Viti di fissaggio

### Da ordinare a parte:

- Piastra copriserratura

## Electric rim locks for doors and gates

### Features:

- Reversibile
- **Single backset adjustable** from 50 to 70 mm.
- **Striker with adjustable height**
- **Center distance of standardized fixing holes**
- Self locking latch
- Fixed or loose cylinder
- Steel lock case
- Power supply 8 - 12 V
- Finish
  - Galvanized
  - Metal grey painting

### Packaging:









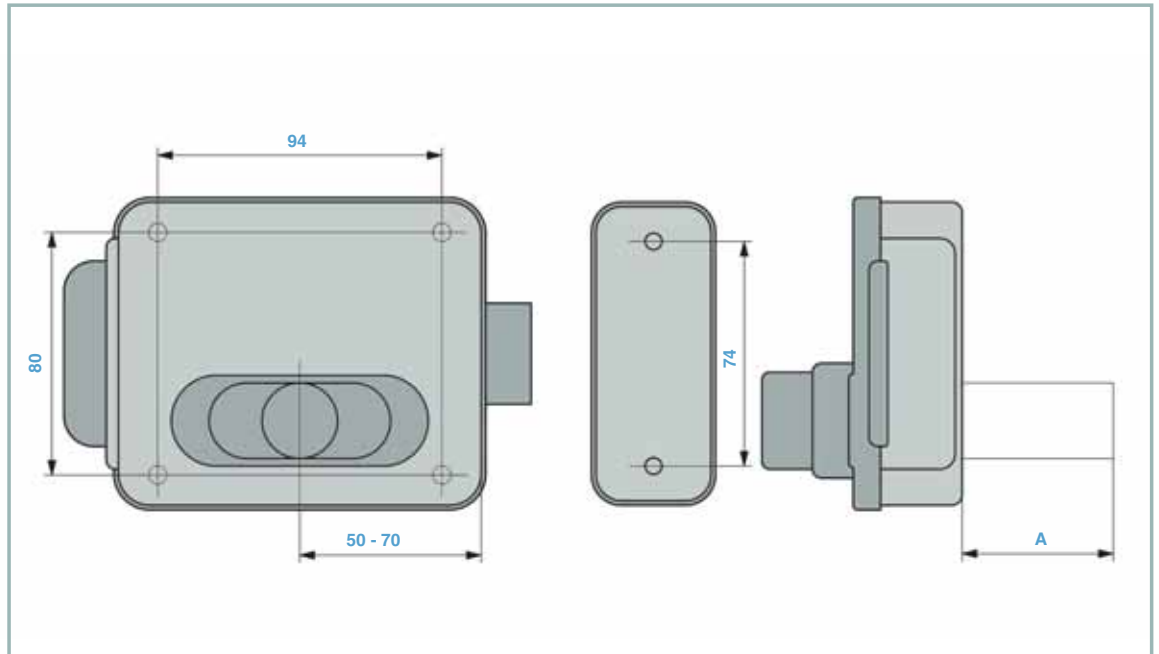

- 3 Keys
- 1 Striker
- Fixing screws

### To be ordered separately:

- Lock holding plate





	Codice / Code	A mm	Cilindro esterno / Out door cylinder		
Solo cilindro Cylinder only	5011/1*	50		1.524	10
	5011/60/1*	60		1.540	10
	5012/1*	-		1.508	10
Solo pulsante Button only	5013/1*	50		1.412	10
	5013/60/1*	60		1.482	10
	5014/1*	-		1.428	10
Pulsante a cilindro Button and cylinder	5015/1*	50		1.556	10
	5015/60/1*	60		1.570	10
	5016/1*	-		1.532	10

Finiture disponibili  
Available finish

\*Z = Zincata / Galvanized

\*GR = Grigio metallizzato / Metal grey painting

# Multipla

## Elettroserrature con pistoni per porte e cancelli

### Caratteristiche tecniche:

- Reversibile
- Entrata unica regolabile da 50 a 70 mm.
- Incontro regolabile in altezza
- Interassi dei fori di fissaggio unificati
- Scrocco autobloccante
- Con cilindro fisso o staccato
- Scatola in acciaio
- Alimentazione 8 - 12 V
- Pistoni meccanici per elevare la sicurezza
- Finiture
  - Zincata
  - Verniciata grigio metallizzato

### Confezione:

- 3 Chiavi
- 1 Bocchetta
- Viti di fissaggio

### Da ordinare a parte:

- Piastra copriserratura

## Electric rim locks for doors and gates

### Features:

- Reversibile
- *Single backset adjustable from 50 to 70 mm.*
- *Striker with adjustable height*
- *Center distance of standardized fixing holes*
- *Self locking latch*
- *Fixed or loose cylinder*
- *Steel lock cases*
- *Power supply 8 - 12 V*
- *Mechanical pistons for high security*
- Finish
  - Galvanized
  - Metal grey painting

### Packaging:

- 3 Keys
- 1 Striker
- Fixing screws



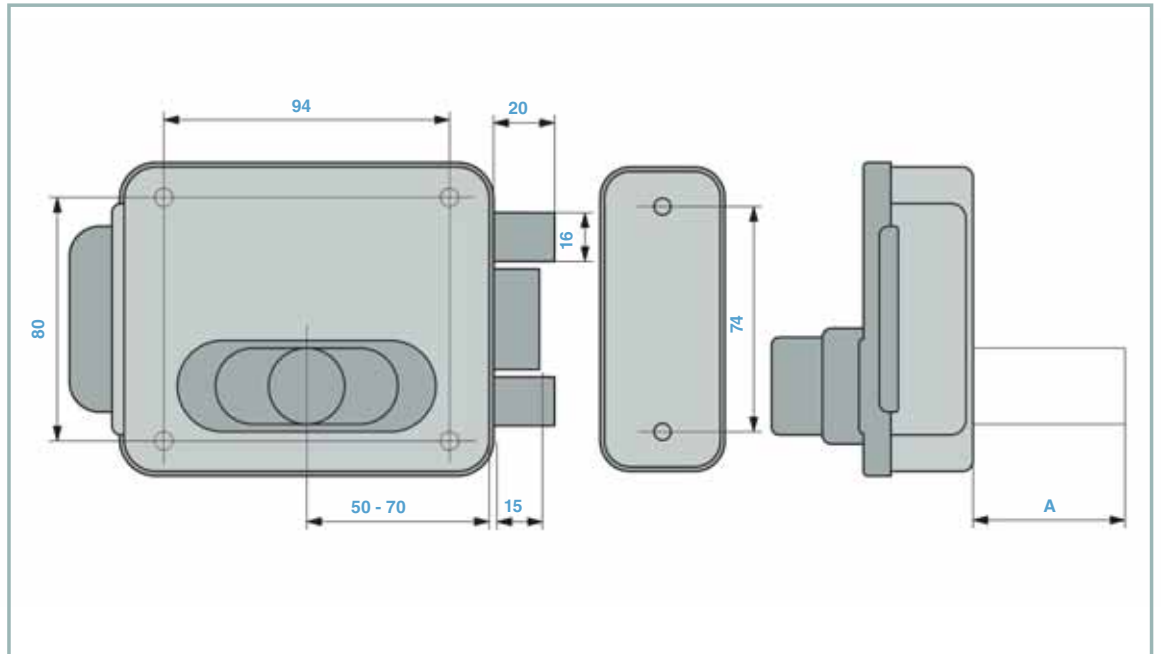

### To be ordered separately:

- Lock holding plate





Solo cilindro  
Cylinder only

Codice / Code	A mm	Cilindro esterno / Out door cylinder	 gr.	
6001/1*	50		1.982	6
6001/60/1*	60		1.990	6
6002/1*	-		1.988	6

Finiture disponibili  
Available finish

\*Z = Zincata / Galvanized

\*GR = Grigio metallizzato / Metal grey painting

# Accessori per Multipla

## Accessories for Multipla



Codice / Code



Piastra copriserratura e porta incontro in acciaio zincato  
*Lock holding plate galvanized steel*

5050

574

30



Codice / Code

mm



Kit prolunga cilindro fisso  
*Extension for fixed cylinder*

112/80

80

64

1

112/100

100

74

1

112/110

110

78

1



Codice / Code



Cilindro fisso per Multipla serie 5013 / *Cylinder for lock 5013*

107F

226

1

Cilindro fisso per Multipla serie 5014 / *Cylinder for lock 5014*

108F

158

1

Coppia cilindri per Multipla serie 5011, 5015  
*Double cylinders for locks 5011, 5015*

112F

226

1

112/1F

226

1

Coppia cilindri per Multipla serie 5012, 5016  
*Double cylinders for locks 5012, 5016*

113F

228

1

Coppia cilindri per Multipla serie 6001  
*Double cylinders for locks 6001*

122F

226

1

Coppia cilindri per Multipla serie 6002  
*Double cylinders for locks 6002*

123F

226

1



Codice / Code



Coppia contatti / *Contact set*

6360

30

15



Codice / Code



Bobina di ricambio / *Coil*

804

46

1

# Accessori cancelli

## Accessories gates

In acciaio lucido - Viti e  
rondelle in acciaio zincato  
Steel - Screws and washers  
in galvanized steel



Codice / Code



Cerniera regolabile per cancelli  
Adjustable hinge for gate

5100

492

20

In acciaio lucido - Perno  
a vite e dadi in acciaio zincato  
Steel - Pin and screwnuts  
in galvanized steel



Codice / Code



Perno regolabile per cancelli  
Adjustable pin for gates

5120

902

20

In acciaio zincato  
tropicalizzato  
Galvanized steel



Codice / Code



Battente / Stop latch

5220

615

10

## 500 Apriporta / 500 Door open



### Caratteristiche tecniche:

- Da abbinare alle serrature meccaniche con tirante
- Alimentazione 8-12 V

### Features:

- To use with mechanical rim locks
- Power supply 8-12 V

Codice / Code



Dx / Rhs

500/5

834

1

Sx / Lhs

500/6

834

1



Codice / Code



Bobine / Coils

803/1

72

1



ASSA ABLOY Italia S.p.A.  
Via Modena 68 - 40017 San Giovanni in Persiceto (BO) Italy  
Tel. +39 051 6812411 - Fax +39 051 827486  
info@assaabloy.it - www.assaabloy.it

ASSA ABLOY is the global leader in door opening solutions, dedicated to satisfying end-user needs for security, safety and convenience.

[www.assaabloy.com](http://www.assaabloy.com)



ASSA ABLOY Italia S.p.A. si riserva di apportare in qualunque momento e senza preavviso le modifiche necessarie per migliorare ed evolvere le caratteristiche dei propri prodotti. Fotografie, illustrazioni e descrizioni sono da ritenersi indicative.  
ASSA ABLOY Italia S.p.A. reserves the right at any time, and without notice, the necessary modifications in order to improve and evolve the characteristics of their products. Photographs, illustrations and descriptions ought to be considered as indicative.

H001601/01-2008